

# Rotor Kick Jr. (RKJ) Automated Assembly Retaining Ring Tool for RG-31 Rings



This ergonomic tool from Rotor Clip provides operator convenience and comfort along with efficient automated assembly. No electrical connections required. The tool is operated by air pressure for convenience and safety. And Carpal Tunnel Syndrome (CTS) injuries, caused by repetitive use of a manual tool, are eliminated. This hand-held tool is lightweight, portable and easy to use. A patented feeder mechanism, designed and built by Rotor Clip personnel, assures efficient, trouble-free operation.

Note: RG Rings must be purchased stacked for use the with Rotor Clip tool. Please inquire for size availability.

## External

for use with the following retaining ring:



**\*\*For RG-31 rings only\*\***

*Please wear protective eyewear while installing and removing retaining rings & hose clamps.*

**For Technical Assistance, call +1.723.469.7333  
or e-mail [tech@rotorclip.com](mailto:tech@rotorclip.com)**



Rotor Kick Jr. Automated Assembly Retaining Ring Tool

# RKJ-RG31 REPLACEMENT PART LISTING

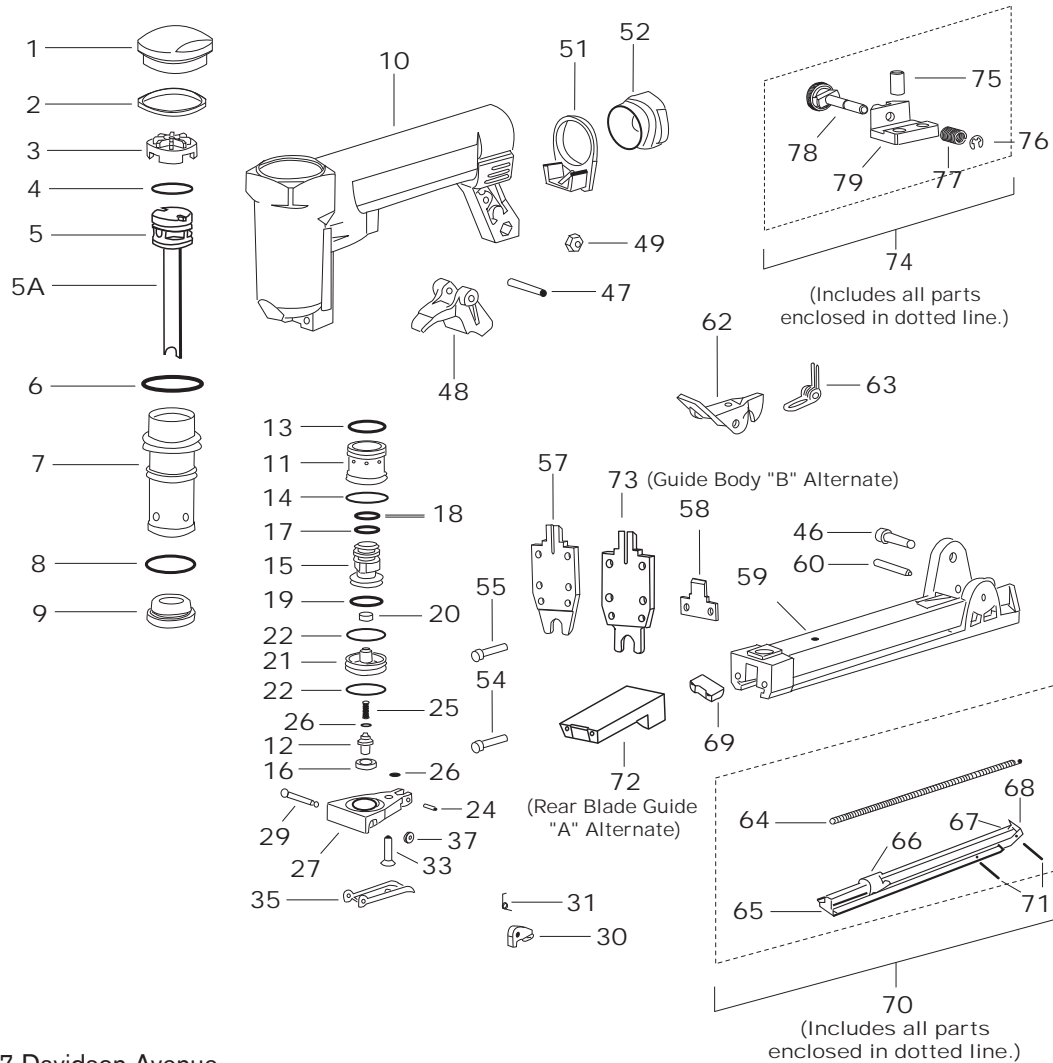

Item	Part Number	Description
1	430082	Cap
2	166022	Seal
3	9292-311	Spacer
4	622325	Seal
5	9292-306	Piston Assembly
5A	9292-306A	Blade
6	622121	Seal
7	700108	Cylinder
8	622115	Seal
9	280037	Stop
10	138176	Body
11	92094	Housing
12	288173	Stud
13	622074	Seal
14	622122	Seal
15	300314	Piston
16	166026	Gasket
17	622005	Seal
18	622035	Seal
19	622035	Seal
20	70002	Cushion
21	140086	Valve
22	622122	Seal
24	662021	Pin
25	200057	Spring
26	622025	Seal
27	294102	Plate
29	288172	Pin
30	184081	Trigger Lever Safety
31	200155	Spring
33	667022	Screw
35	164061	Trigger
37	348012	Retainer
46	666032	Screw
47	662019	Pin
48	184062	Latch
49	650005	Nut
51	430045	Bracket
52	326037	Adapter
54	632	#6-32 Screw
55	666022	Screw
57	9292-308	Guide Body
58	9292-310	Plate
59	172342	Housing
60	662019	Pin
62	184061	Latch
63	200145	Spring
64	200033	Spring
65	9292-301	Rail
66	9292-304	Pusher
67	LC-022A-08	Latch Spring
68	9292-305	Latch
69	9292-307	Rear Blade Guide
70	9292-300	Rail Assembly
71	90692A084	Roll Pin
72	9292-307A	Rear Blade Guide "A"
73	9292-308B	Guide Body "B"
74	9292-404	Rail Lock Assembly
75	90692A241	Roll Pin
76	RE-12ST PA	Retaining Ring
77	LC-022BC-3	Spring
78	9292-402	Rail Lock Pin
79	9292-403	Housing

187 Davidson Avenue  
Somerset, NJ 08873  
Phone: +1 732.469.7333  
Fax: +1 732.469.7898  
sales@rotorclip.com  
www.rotorclip.com

